



CHEMISE - CHEMISE XL

design Piero Lissoni

Fix or modular sofa and armchair with supporting frame in lacquered drawn tubular steel. Seat frame in fir wood, with crosswoven, coated rubber elastic straps. Backrest and armrest frames made with a structural elastic material. Shell covering in 100% polyether thermally bonded onto a polyamide velveteen backing. Seat cushions padded with polyurethane foam and coated with prewashed and sterilized goose down, stitched into separate compartments or polyurethane covered with acrylic fibre layers. Backrest cushions with polyurethane foam coated with prewashed and sterilized

goose down, stitched into separate compartments. The coverings of the backrest and seat cushions are joined together by zippers. Loose cushions in prewashed and sterilized goose down, stitched into separate compartments. Tubular feet in AISI 304 Stainless Steel with matt satin-finish or, on request, available in natural or ebony-dyed oak. Fabric or leather upholstery, both fully removable by zippers and Velcro fastenings. Standard flounce 7 cm from the floor for fabric upholstery only, on request available also without flounce, to be confirmed on the order. The leather version is always without flounce. Seat depth: 61-81 cm.

Feet



Stainless Steel
with Matt Satin
Finish



Natural Oak



Ebony Dyed
Oak

Notes

The version with flounce is not available for leather and velvet upholstery.

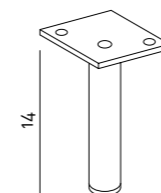

Standard foot in Stainless Steel
AISI 304.

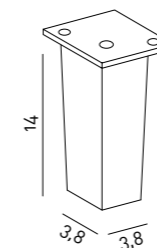

On request, foot in natural
or ebony-dyed oak.

For composition with different elements, please attach a general sketch to the order.

Technical Drawings

Armchair

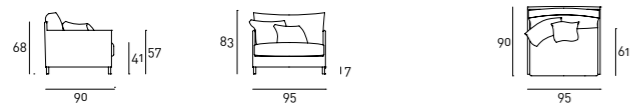

Sofa

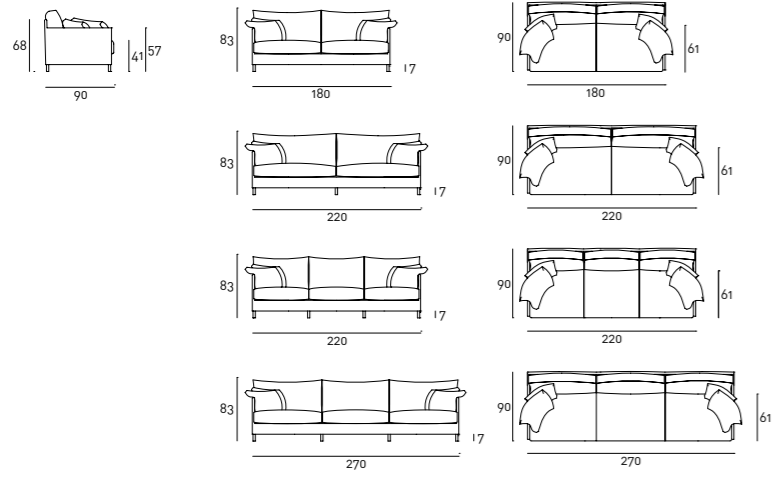

Terminal Element

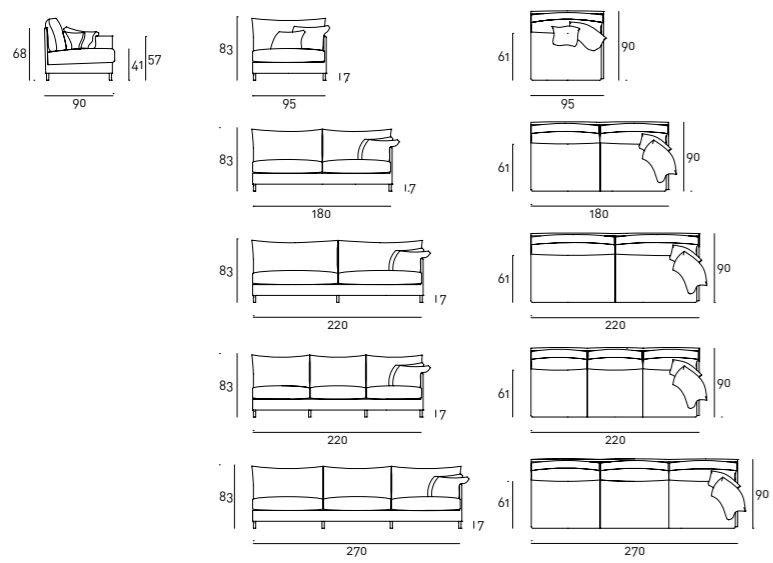

Central Element

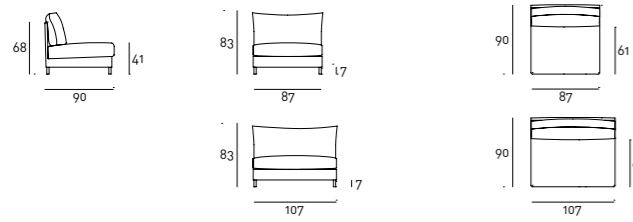

Corner Element

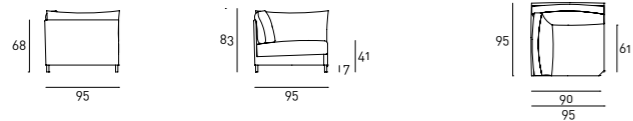

Long Seat



Chemise XL
Armchair

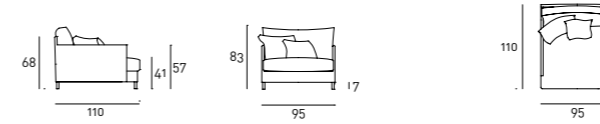

Sofa

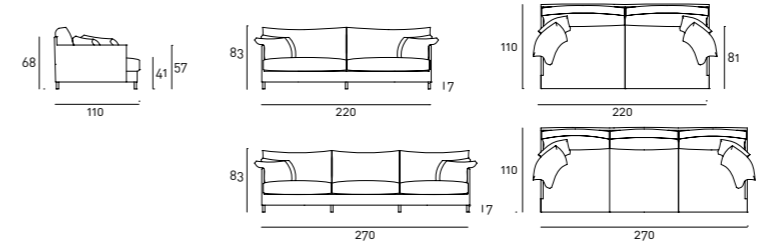

Footrest

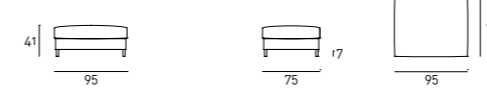

Loose Cushion

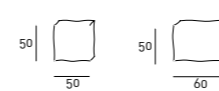

Examples of Composition

Composition 01

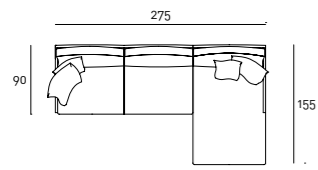

CHET180 SX
CHES155 DX

Composition 02

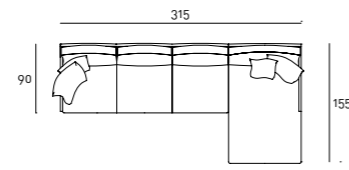

CHET223 SX
CHES155 DX

Composition 03

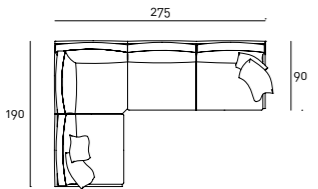

CHET095 SX
CHEA095
CHET180 DX

Composition 04

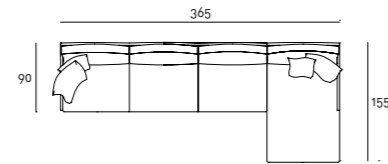

CHET270 SX
CHES155 DX

Composition 05

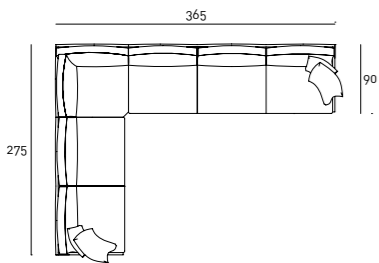

CHET180 SX
CHEA095
CHET270 DX

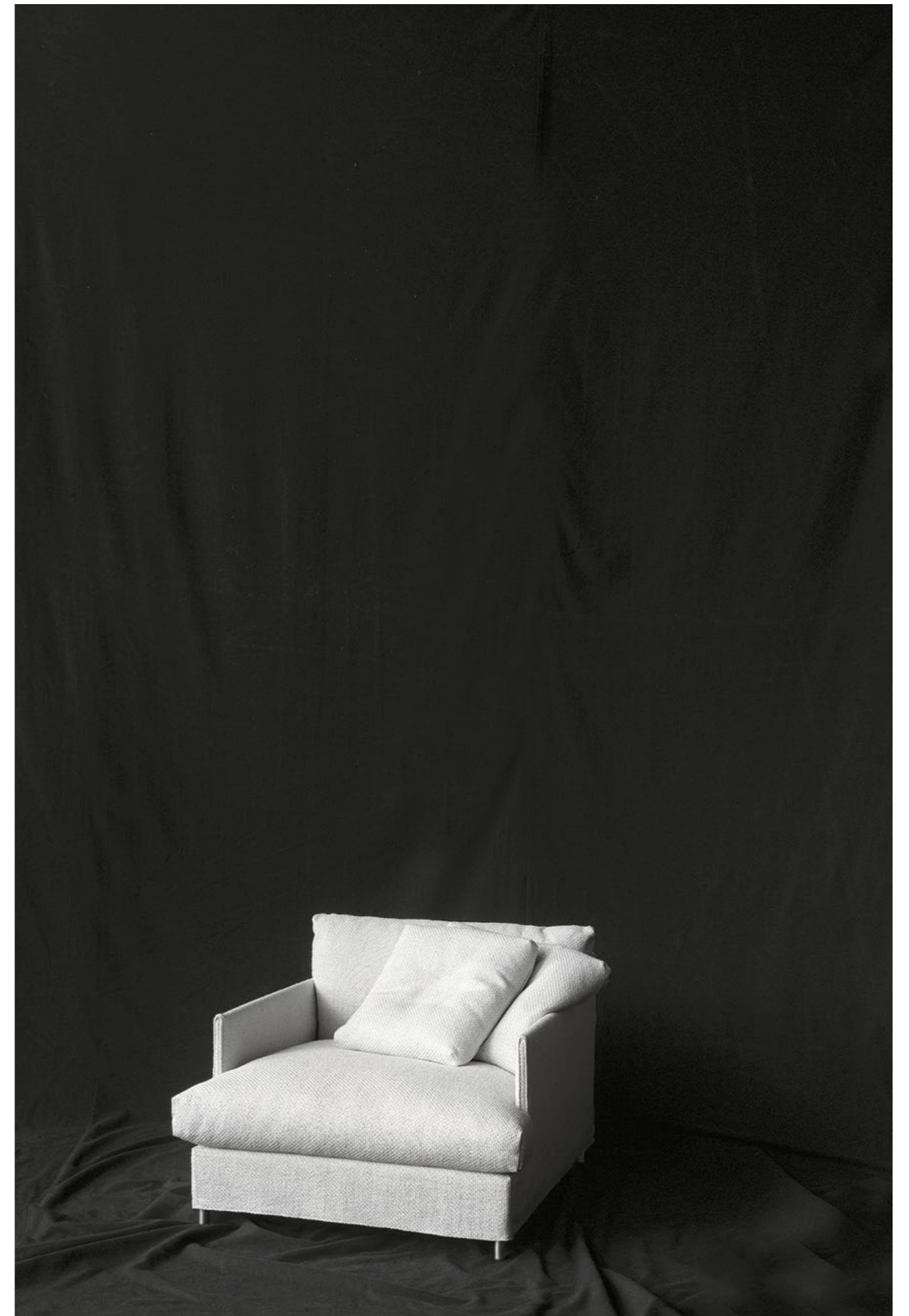

The commercial codes refer to the elements chosen in the above-proposed compositions.